

WAPRO®

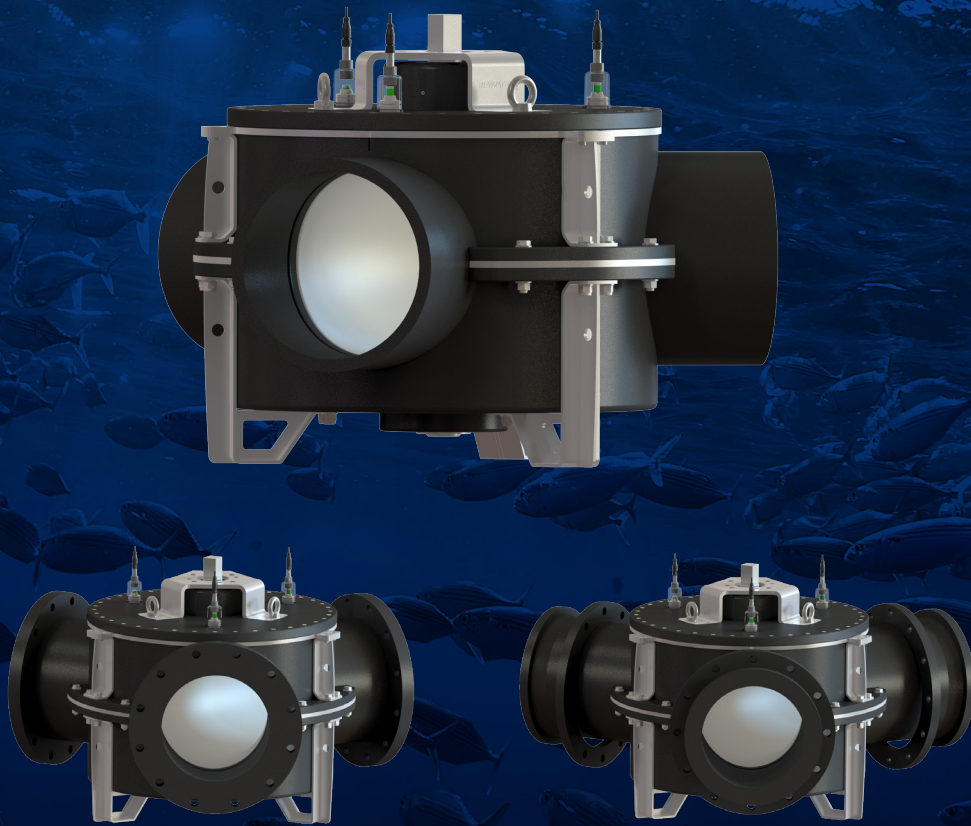

FLOW GUIDE 3-WAY VALVE

EQUIPMENT FOR AQUACULTURE

Product development is Wapros core competence, where we provide competent advice and sparring throughout the entire process from idea to finished and delivered product.

Together with our customers, we develop customized solutions that suit your specific needs. The most important factor for the development of customer-specific solutions is the direct dialogue with our customers.

RAS - RECIRCULATION AQUACULTURE SYSTEMS

The Aquaculture industry is in a rapid development. To really understand what specific products are needed in the facility, a proper hands on experience is required.

During the last year, Wapro has had at least one of our Aquaculture specialists on-site on RAS facilities in Denmark, Norway and the USA.

Based on this experience from on sites, as well as our over 35 years of experience in Aquaculture, we are proud to be able to present the Flow Guide 3-way valve.

The valve is especially gentle to avoid damage to fish and is a perfect solution in RAS.

Flow Guide 3-Way valve gives you peace of mind and good performance

- The radius of the bend in the core is developed to reduce damage to fish
- The HDPE lid has an optimized thickness for pressure in RAS
- Easy to maneuver with ball bearings
- Easy to install

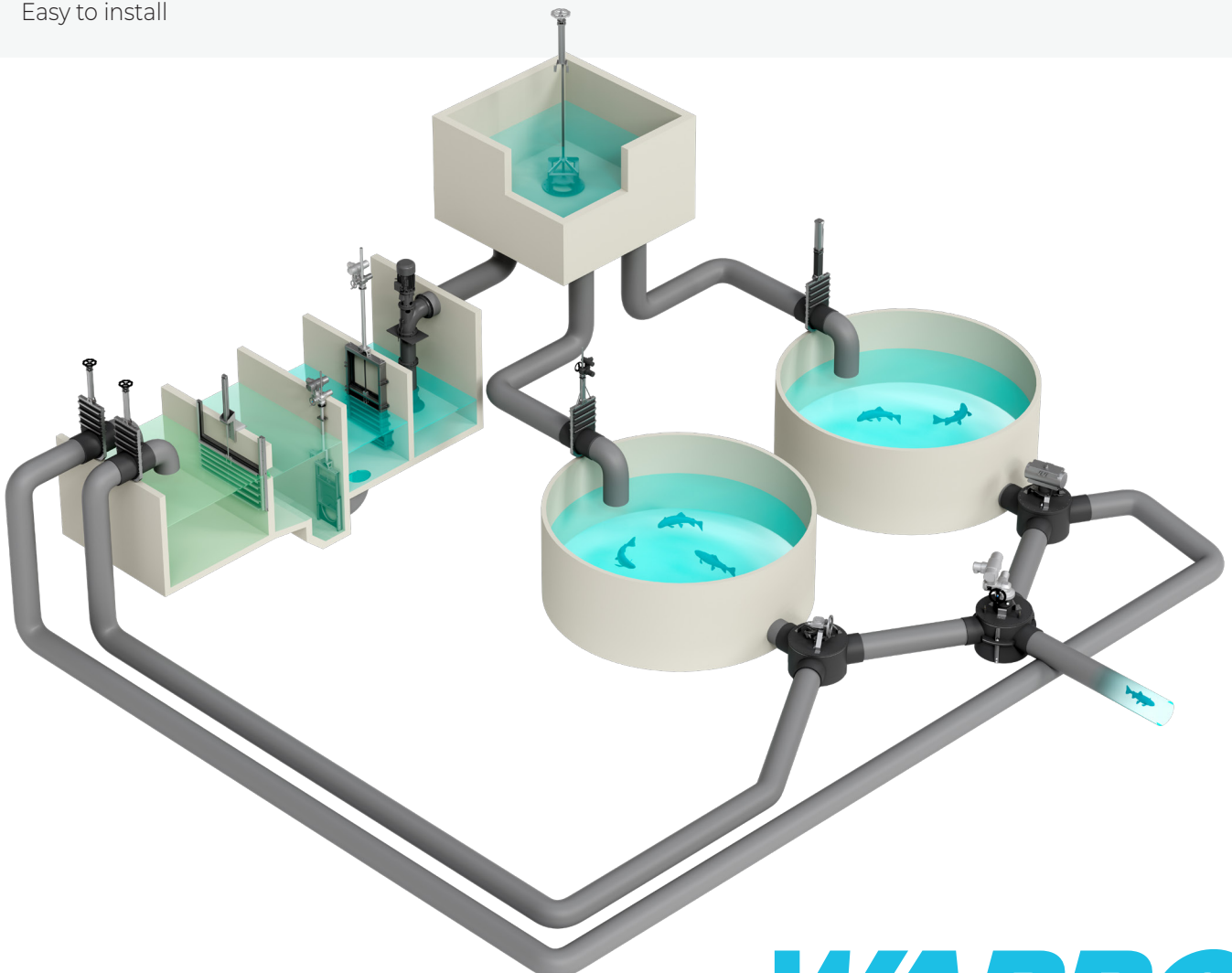

WAPRO[®]

FLOW GUIDE 3-WAY VALVE

MECHANICAL POSITION INDICATOR

- Easy to see the position of the core, to avoid misalignment
- Protected indicator to avoid risk of corrosion damage
- Stainless precision cam ensured correct reading

BEARING HOUSING

- Ball bearing for easy operation
- Can be serviced while under pressure - no need to drain system, which reduces downtime
- Long service intervals

CONTROL AND MAINTANANCE

- ISO 5211 Interface prepared for multiple actuators
- Low maintenance cost
- Long lifecycle



STABILITY

- Rated for pressure of 1,5 bar and 0,7 bar vacuum
- Stable construction due to internal local bearing
- Low risk of deflection or leakage

NO SHARP EDGES

- To create the best and smoothest connections, the valve is created with rounded internal edges and big radius 120 degree pipe connections
- Decrease damage to fish which leads to a greater output and more profitability

INSTALLATION

- Support brackets with lifting eyes
- Legs with fixing plates
- Quick easy installation which lower costs
- Available with stub end, flanges and loose flanges

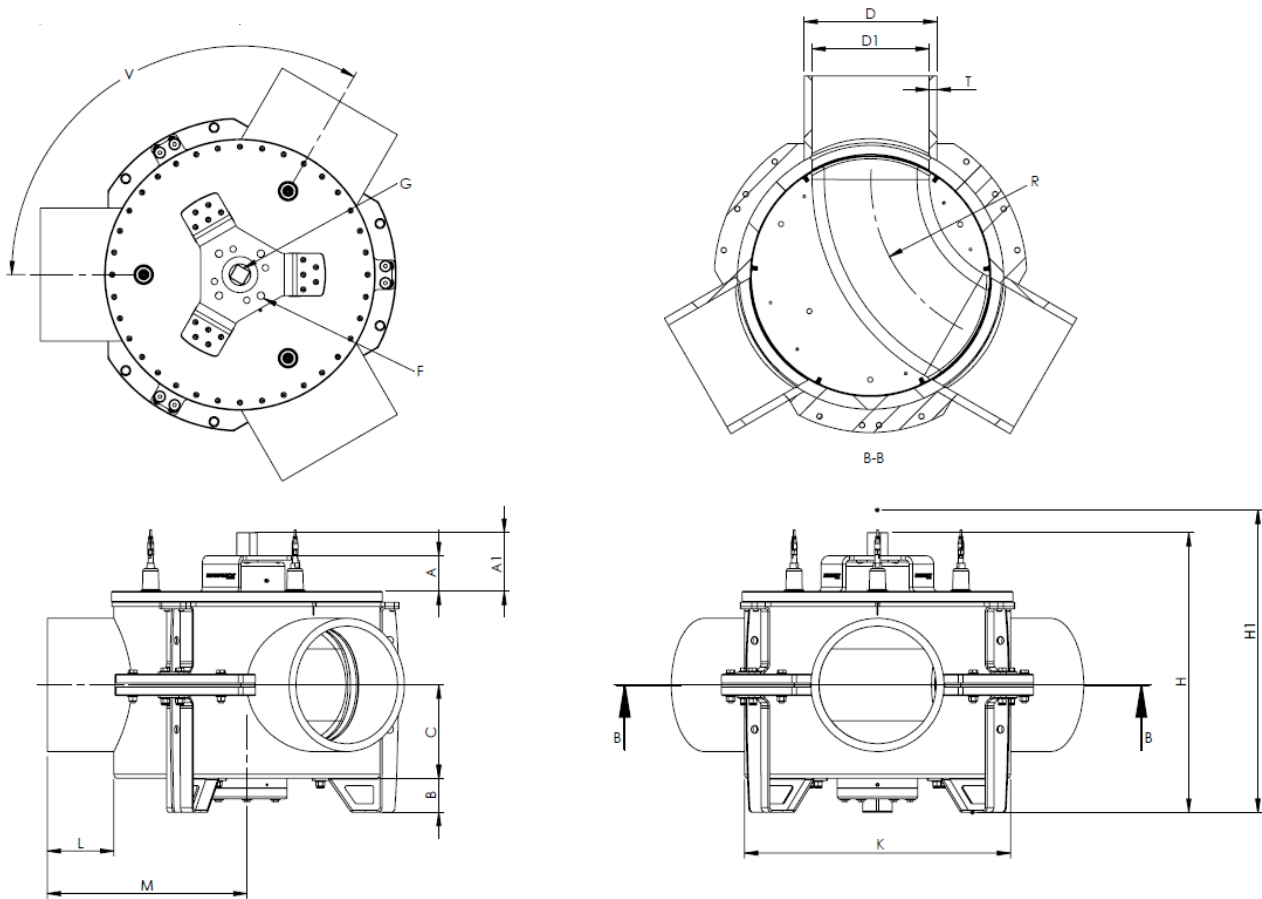

DIMENSIONS [MM] AND KOLUMN F [MM, ACCORDING TO ISO 5211]

Sizes	A	AI	B	C	D	D1	F	G	H	HI	K	L	M	R	T	V
DN 100	-	-	-	107	Ø110	Ø96,8	-	-	315	-	Ø250	100	225	145	6,6 (SDR 17)	120 °
DN 150	-	-	-	124	Ø160	Ø141	-	-	365	-	Ø315	110	268	200	9,5 (SDR 17)	120 °
DN 200	100	132	-	147	Ø200	Ø176.2	F10	22x22	435	Upon request	Ø400	135	335	200	11,9 (SDR 17)	120 °
DN 250	100	132	-	176	Ø250	Ø220.4	F10	22x22	493	Upon request	Ø500	180	430	300	14,8 (SDR 17)	120 °
DN 300	90	139	80	221	Ø315	Ø277.6	F12 + F14	36x36	661	Upon request	Ø630	160	473	400	18,7 (SDR 17)	120 °
DN 350	90	139	80	246	Ø355	Ø312.8	F12 + F14	36x36	710	Upon request	Ø710	175	530	500	21,1 (SDR 17)	120 °
DN 400	90	139	80	251	Ø400	Ø369.4	F12 + F14	36x36	730	Upon request	Ø800	200	600	520	15,3 (SDR 26)	120 °
DN 450	90	139	80	288	Ø450	Ø415.6	F12 + F14	36x36	800	Upon request	Ø900	230	680	625	17,2 (SDR 26)	120 °
DN 500	90	139	80	325	Ø500	Ø461.8	F12 + F14	36x36	870	Upon request	Ø1000	260	760	735	19,1 (SDR 26)	120 °

House	Lid	Core	Gasket in core	Gasket in lid	Oil seal	Steel	Bolts and screws
PEHD 100	PEHD 500	PEHD 500	Silikone	EPDM	NBR / 316 Stainless steel	316 Stainless steel	316 Stainless steel

WEIGHT [KG]FOR STANDARD MODELS

	DN 100	DN 150	DN 200	DN 250	DN 300	DN 350	DN 400	DN 450	DN 500
Weight	12	21	35	63	151	210	260	395	465

CONTACT WAPRO:

customerservice@wapro.com
wapro.com

SE: +46 (0)454 185 10
DK: +45 64 82 40 00
US: +1 888 927 8677
UK: +44 114 308 0123

